

SAL724

SMARTMOUNT **LT**

Articulating Wall Mount

For 10" to 24" Displays

The SmartMountLT™ series articulating wall mounts give the ultimate in display positioning, with one-person, Hook-and-Hang™ easy installation. The articulating arm allows you to extend the display up to 14.58" (370mm) from the wall, and can retract to just 2.48" (63mm) from the wall. The integrated cable management provides a clean, professional finish. One-Touch™ tilt of $\pm 15^\circ$, $\pm 5^\circ$ roll for post-installation leveling and $\pm 90^\circ$ pivoting means the display will be perfectly positioned for the optimum viewing angle.



Display size: 10"-24"



Max load: 25lb (11kg)

FEATURES

- Fits 10" to 24" displays, up to 25lb (11kg)
- Extends display 14.58" (370mm) from the wall
- Retracts to hold display just 2.48" (63mm) from the wall
- $\pm 90^\circ$ of pivot allows for perfect display positioning
- Quick and easy, Hook-and-Hang™ one-person installation
- Integrated cable management provides clean, professional installation finish
- Easy leveling $\pm 5^\circ$ after display installation
- Landscape or portrait mounting options increases display versatility
- Mounts to wood studs, concrete, cinder block or metal studs (metal stud accessory required)
- VESA® 75 and 100mm compliant
- Installation hardware included
- UL Listed
- Five-year warranty

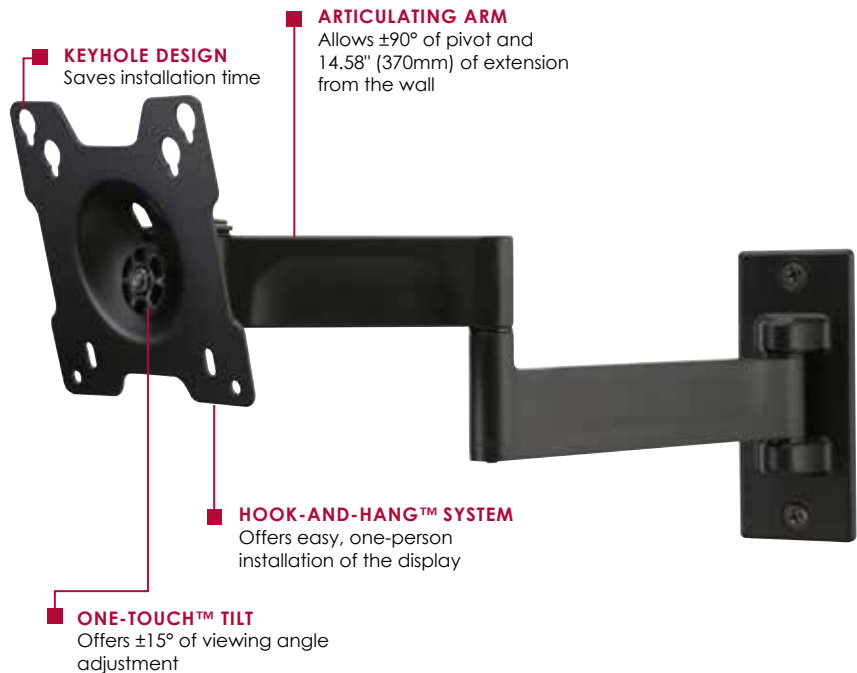

$\pm 15^\circ$ of viewing angle adjustment

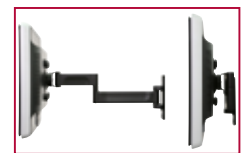

Arm retracts to just 2.48" (63mm) and extends up to 14.58" (370mm) from the wall



| | |
|---------------|---|
| SAL724 | SmartMountLT™ Articulating Wall Mount for 10" to 24" Displays |
|---------------|---|

Product Specifications

| | DIMENSIONS (W x H x D) | PRODUCT WEIGHT | LOAD CAPACITY | FINISH | AVAILABLE COLORS |
|---------------|--|-----------------|---------------|--------|------------------|
| SAL724 | 8.97" x 7.53" x 2.48"-14.58" (228 x 191 x 63-370mm) | 2.16lb (0.98kg) | 25lb (11kg) | Matte | Black |

Package Specifications

| | PACKAGE SIZE (W x H x D) | PACKAGE SHIP WEIGHT | PACKAGE UPC CODE | PACKAGE CONTENTS | UNITS IN PACKAGE |
|---------------|---|---------------------|------------------|---|------------------|
| SAL724 | 9.45" x 8.00" x 2.25" (240 x 203 x 57mm) | 2.75lb (1.25kg) | 735029292524 | Wall mount, attachment hardware and installation instructions | 1 |

Accessories

| | | | |
|----------------|----------------------------------|--------------------|----------------------------------|
| ACC972: | VESA® 200 x 100mm Adaptor Plates | ACC918: | Security Fasteners for Wall Arms |
| ESHV10: | Single AV Wall Shelf | WSP700/701: | Metal Stud Wall Plate |
| ESHV20: | Single AV Wall Shelf with Glass | | |
| ESHV30: | Dual AV Wall Shelf with Glass | | |

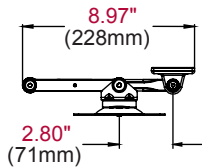

TOP VIEW

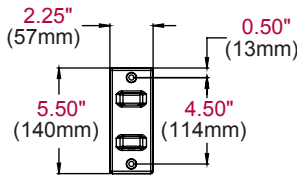

WALL PLATE

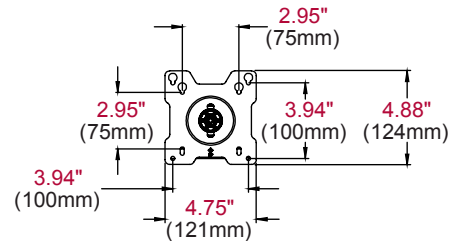

ADAPTER PLATE

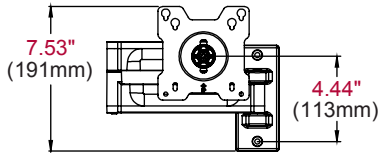

FRONT VIEW

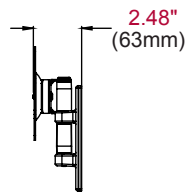

SIDE VIEW

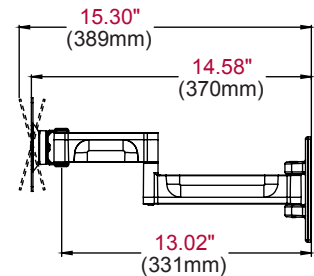

SIDE VIEW
EXTENDED
+/-15° TILT

ARCHITECTS SPECIFICATIONS

The Articulating Wall Mount shall be a Peerless-AV model SAL724 and shall be located where indicated on the plans. Assembly and installation shall be done according to instructions provided by the manufacturer.